

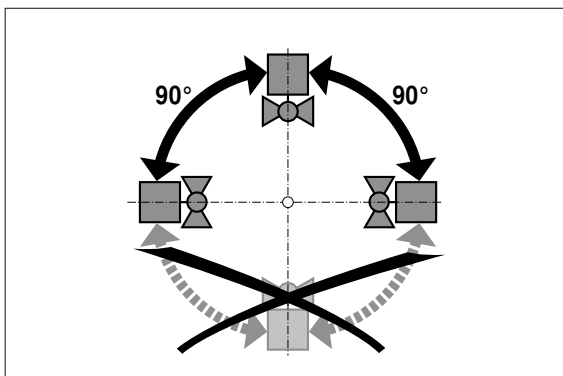

EXT-R2..B..PW

t 10 ... 65 °C								
p _s 1000 kPa								
	DN	Rp	mm					
	mm	"	L	H	L1	X	Y	
EXT-R215-B3-PW	15	1/2"	59	53	13	250	90	
EXT-R220-B3-PW	20	3/4"	64	57	14	250	90	
EXT-R225-B3-PW	25	1"	81	61	16	250	90	
EXT-R232-B4-PW	32	1 1/4"	93	80	19	270	90	
EXT-R240-B4-PW	40	1 1/2"	102	86	19	270	90	
EXT-R250-B5-PW	50	2"	121	83	22	270	90	

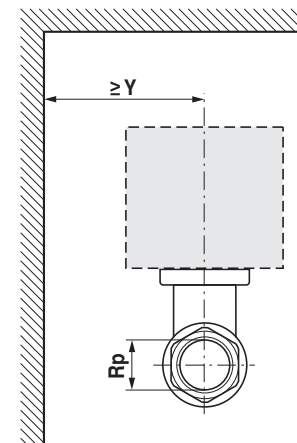
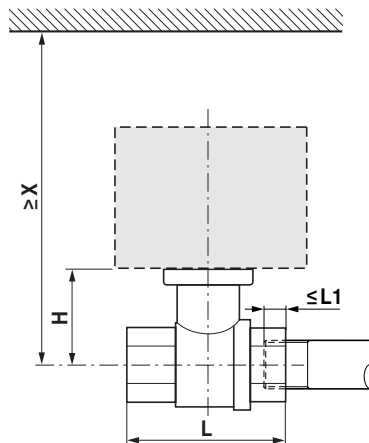
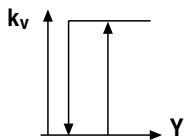

$\Delta p_{vmax} < 1000 \text{ kPa}$

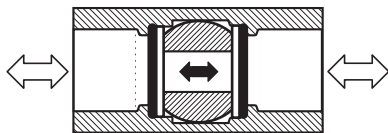

< DN 50

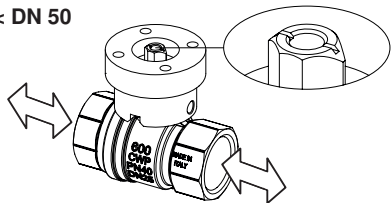

100%

DN 50

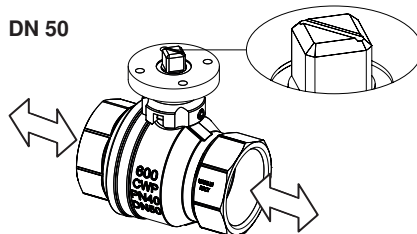

100%

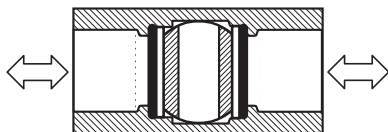

< DN 50

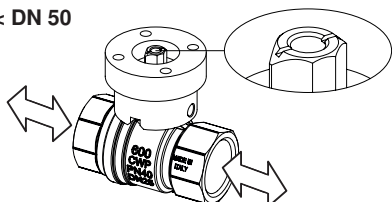

0%

DN 50

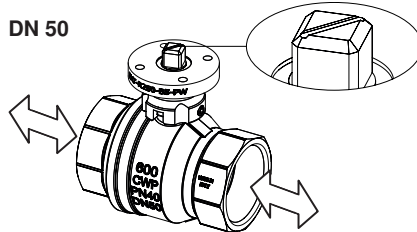

0%

< DN 50

