

Globe valve actuator for 2-way and 3-way globe valves

- Actuating force 500 N
- Nominal voltage AC 230 V
- Control Open/close, 3-point
- Stroke 15 mm

Technical data

Electrical data	Nominal voltage	AC 230 V
	Nominal voltage frequency	50/60 Hz
	Nominal voltage range	AC 85...265 V
	Power consumption in operation	2 W
	Power consumption in rest position	1 W
	Power consumption for wire sizing	4 VA
	Connection supply / control	Terminals with cable 1 m, 3 x 0.75 mm ² (Terminal 4 mm ²)
	Parallel operation	Yes (note the performance data)
Functional data	Actuating force motor	500 N
	Manual override	with push-button, can be locked
	Stroke	15 mm
	Running time motor	150 s / 15 mm
	Sound power level, motor	45 dB(A)
	Position indication	Mechanically, 5...15 mm stroke
Safety	Protection class IEC/EN	II reinforced insulation
	Protection class UL	UL Class 2 Supply
	Degree of protection IEC/EN	IP54
	Degree of protection NEMA/UL	NEMA 2
	Enclosure	UL Enclosure Type 2
	EMC	CE according to 2014/30/EU
	Low voltage directive	CE according to 2014/35/EU
	Certification IEC/EN	IEC/EN 60730-1 and IEC/EN 60730-2-14
	Certification UL	cULus according to UL60730-1A, UL60730-2-14 and CAN/CSA E60730-1:02
	Certification UL note	The UL marking on the actuator depends on the production site, the device is UL-compliant in any case
	Mode of operation	Type 1
	Rated impulse voltage supply / control	4 kV
	Control pollution degree	3
Ambient temperature	0...50 °C	
Storage temperature	-40...80 °C	
Ambient humidity	Max. 95% r.H., non-condensing	
Servicing	maintenance-free	
Weight	Weight	1.1 kg

Safety notes



- This device has been designed for use in stationary heating, ventilation and air-conditioning systems and must not be used outside the specified field of application, especially in aircraft or in any other airborne means of transport.
- Outdoor application: only possible in case that no (sea) water, snow, ice, insolation or aggressive gases interfere directly with the actuator and that is ensured that the ambient conditions remain at any time within the thresholds according to the data sheet.
- Only authorised specialists may carry out installation. All applicable legal or institutional installation regulations must be complied during installation.
- The switch for changing the direction of motion and so the closing point may be adjusted only by authorised specialists. The direction of motion is critical, particularly in connection with frost protection circuits.
- The device may only be opened at the manufacturer's site. It does not contain any parts that can be replaced or repaired by the user.
- The device contains electrical and electronic components and must not be disposed of as household refuse. All locally valid regulations and requirements must be observed.

Product features

Simple direct mounting	Simple direct mounting on the globe valve by means of form-fit hollow clamping jaws. The actuator can be rotated by 360° on the valve neck.
Manual override	Manual override with push-button possible (the gear is disengaged for as long as the button is pressed or remains locked). The stroke can be adjusted by using a hexagon socket screw key (4 mm), which is inserted into the top of the actuator. The stroke shaft extends when the key is rotated clockwise.
High functional reliability	The actuator is overload protected, requires no limit switches and automatically stops when the end stop is reached.
Combination valve/actuator	Refer to the valve documentation for suitable valves, their permitted fluid temperatures and closing pressures.
Position indication	The stroke is indicated mechanically on the bracket with tabs. The stroke range adjusts itself automatically during operation.
Home position	Factory setting: Actuator spindle is retracted. When valve-actuator combinations are shipped, the direction of motion is set in accordance with the closing point of the valve.
Setting direction of stroke	When actuated, the stroke direction switch changes the running direction in normal operation.

Accessories

	Description	Type
Electrical accessories	Auxiliary switch 2 x SPDT add-on	S2A-H

Electrical installation



Notes

- Caution: Power supply voltage!
- Parallel connection of other actuators possible. Observe the performance data.
- Direction of stroke switch factory setting: Actuator spindle retracted (▲).

Electrical installation

Wiring diagrams

AC 230 V, open/close

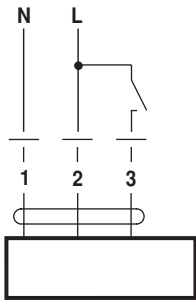

Cable colours:

1 = blue
2 = brown
3 = white

AC 230 V, 3-point

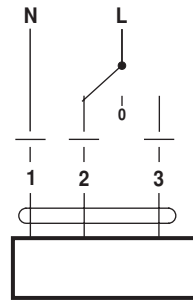

Cable colours:

1 = blue
2 = brown
3 = white

Operating controls and indicators

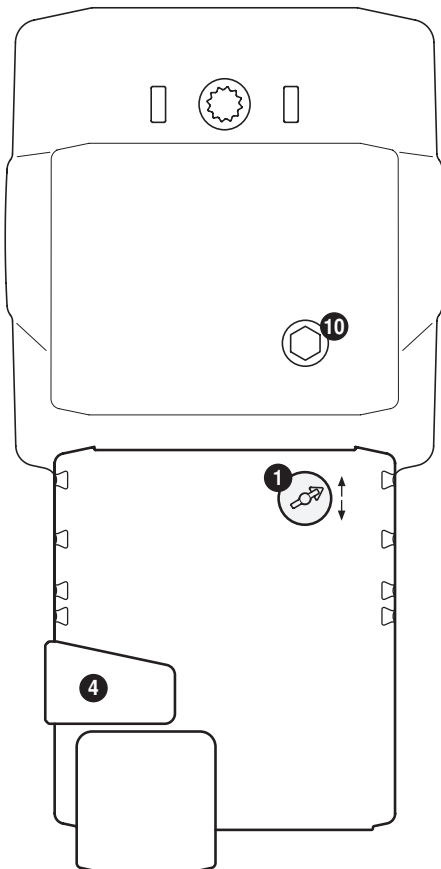

1 Direction of stroke switch

Switch over: Direction of stroke changes

4 Gear disengagement button

Press button: Gear disengages, motor stops, manual override possible
Release button: Gear engages, standard mode

10 Manual override

Clockwise: Actuator spindle extends
Counterclockwise: Actuator spindle retracts

Dimensions [mm]

Dimensional drawings

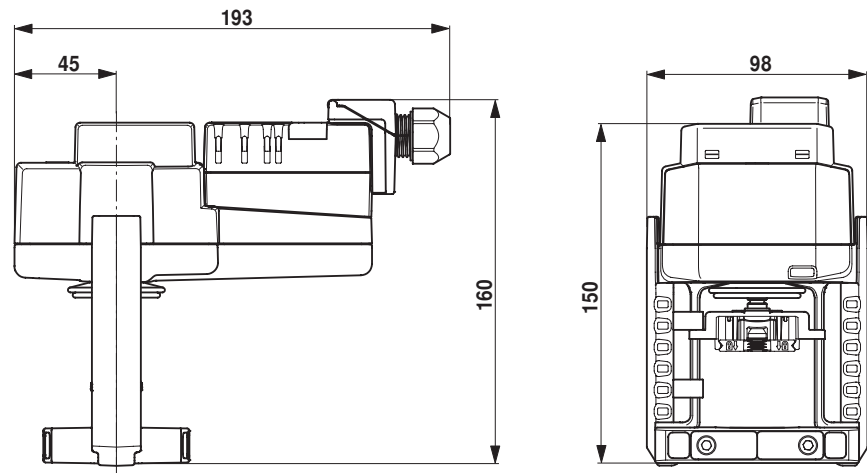

Further documentation

- The complete product range for water applications
- Data sheets for globe valves
- Installation instructions for actuators and/or globe valves
- Notes for project planning 2-way and 3-way globe valves
- General notes for project planning