

Rotary actuator for ball valves

- Torque motor 2 Nm
- Nominal voltage AC/DC 24 V
- Control modulating 2...10 V

Technical data

Electrical data	Nominal voltage	AC/DC 24 V
	Nominal voltage frequency	50/60 Hz
	Nominal voltage range	AC 19.2...28.8 V / DC 21.6...28.8 V
	Power consumption in operation	0.5 W
	Power consumption for wire sizing	1 VA
	Connection supply / control	Cable 1 m, 3 x 0.75 mm ²
	Parallel operation	Yes (note the performance data)
Functional data	Torque motor	2 Nm
	Operating range Y	2...10 V
	Input Impedance	100 kΩ
	Manual override	with hand crank
	Running time motor	35 s / 90°
	Sound power level, motor	45 dB(A)
	Position indication	Mechanical
Safety	Protection class IEC/EN	III Safety Extra-Low Voltage (SELV)
	Degree of protection IEC/EN	IP40
	EMC	CE according to 2014/30/EU
	Certification IEC/EN	IEC/EN 60730-1 and IEC/EN 60730-2-14
	Mode of operation	Type 1
	Rated impulse voltage supply / control	0.8 kV
	Control pollution degree	3
	Ambient temperature	-7...50°C
	Storage temperature	-40...80°C
	Ambient humidity	Max. 95% r.H., non-condensing
Servicing	maintenance-free	
Weight	Weight	1.1 kg

Safety notes



- This device has been designed for use in stationary heating, ventilation and air-conditioning systems and must not be used outside the specified field of application, especially in aircraft or in any other airborne means of transport.
- Outdoor application: only possible in case that no (sea) water, snow, ice, insolation or aggressive gases interfere directly with the actuator and that is ensured that the ambient conditions remain at any time within the thresholds according to the data sheet.
- Only authorised specialists may carry out installation. All applicable legal or institutional installation regulations must be complied during installation.
- The device may only be opened at the manufacturer's site. It does not contain any parts that can be replaced or repaired by the user.
- The device contains electrical and electronic components and must not be disposed of as household refuse. All locally valid regulations and requirements must be observed.
- The switch for changing the direction of rotation may only be operated by authorised specialists. The direction of rotation must not in particular be reversed in a frost protection circuit.

Product features

Mode of operation	The actuator is connected with a standard modulating signal of 0...10 V and drives to the position defined by the positioning signal.
Simple direct mounting	Simple direct mounting on the ball valve with only one screw. The mounting orientation in relation to the ball valve can be selected in 90° steps.
Manual override	Manual override possible with lever (the gearing is disengaged as long as the self-resetting lever is pressed).
High functional reliability	The actuator is overload protected and automatically stops when the end stop is reached. The actuator switches off for seven seconds in the case of blocking, then attempts to restart. If the blocked condition persists, the actuator attempts to restart once every two minutes a total of 15 times and subsequently only once every two hours.
Combination valve/actuator	Refer to the valve documentation for suitable valves, their permitted fluid temperatures and closing pressures.

Electrical installation



Notes

- Connection via safety isolating transformer.
- Parallel connection of other actuators possible. Observe the performance data.

Wiring diagrams

AC/DC 24 V, modulating

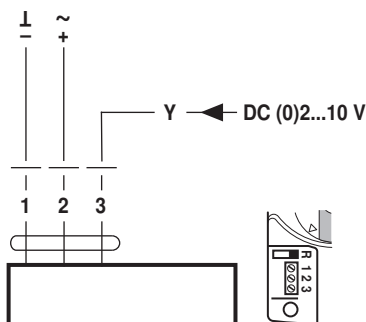

Cable colours:

- 1 = black
- 2 = red
- 3 = white

Direction of rotation R (standard)
when switch set to right position

Electrical installation

AC/DC 24 V, modulating, override control

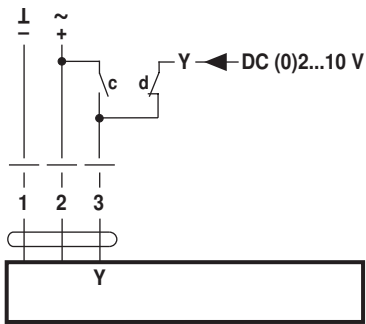

c	d	Y1 / Y2	
		Y1	A - AB = 100%
		Y2	A - AB = 0%
		DC (0)2...10 V	

Cable colours:

- 1 = black
- 2 = red
- 3 = white

Dimensions [mm]

Dimensional drawings

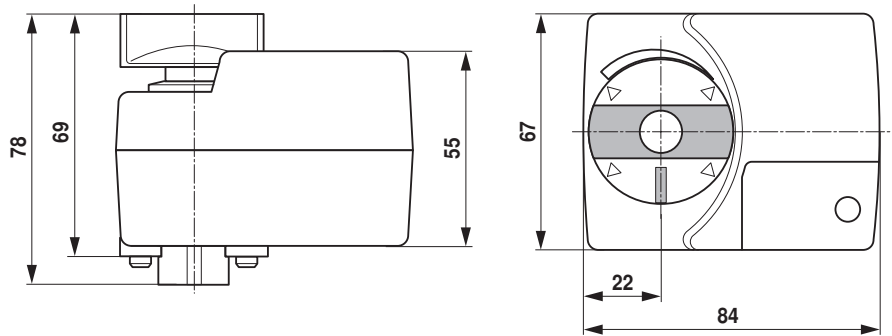

Further documentation

- The complete product range for water applications
- Data sheets for ball valves
- Installation instructions for actuators and/or ball valves
- General notes for project planning